

Step Stringers

Fitting Guide



Kit Contents



Stringer(s)



Deck Boards



50mm Truss Clip(s)



60mm Deck Screws



140mm Joist Screws



30mm Twist Nails



Support Post(s)



M10 x 180mm
Carriage Bolts

Please note these instructions are relevant for all our step stringer kits, however components may differ depending on your kit.

All images are for illustration only. Please see individual item listings for actual item specifications.

Page 1 of 8

Step Stringers

Fitting Guide

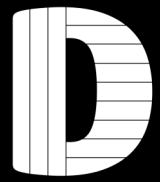

Stringer Specs

Timber Size

2 - 10 Step Pressure Treated C16 Graded Timber 225mm x 47mm (9" x 2")

11 - 18 Step GL24 Glulam Joist Timber 295mm x 44mm (12" x 2")

Step	Height (a) mm	Length (b) mm	Diagonal Length (c) mm
2	450	480	685
3	675	735	1027
4	900	990	1369
5	1125	1245	1711
6	1350	1500	2054
7	1575	1755	2396
8	1800	2010	2738
9	2025	2265	3081
10	2250	2520	3423
11	2475	2775	3765
12	2700	3030	4108
13	2925	3285	4450
14	3150	3540	4790
15	3375	3795	5130
16	3600	4050	5475
17	3825	4305	5815
18	4050	4560	6160

All measurements within this table are subject to a tolerance of +/- 25mm.

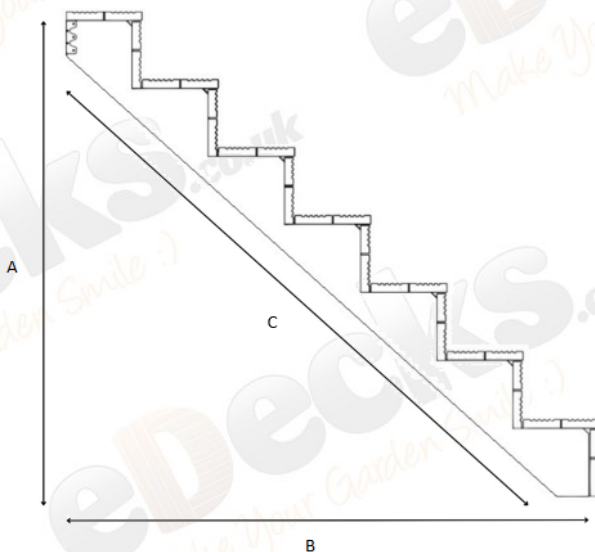

Step Rise: 9" / 225mm Approx

Tread Depth: 10" / 255mm Approx

Note: The top / last tread is slightly smaller at 225mm.

All images are for illustration only. Please see individual item listings for actual item specifications.

Step Stringers

Fitting Guide

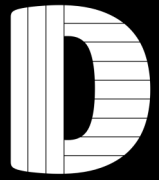

Step 1

SET OUT YOUR STRINGERS

For all kits we recommend a minimum of two people for safe and hassle free assembly.

First make sure the ground is flat and level, then measure and place your stringers at the desired width for your steps.

As shown on the diagram opposite the rise on the stringers should be 9" and the step should be 10", please make sure your stringers are the correct way up.

To ensure maximum stability, we recommend that stringers are spaced no further than 600mm apart at the centers.

Further to this, do not recommend using any boards thinner than 28mm on staircases as they will be subject to flexing and not safe for normal applications.

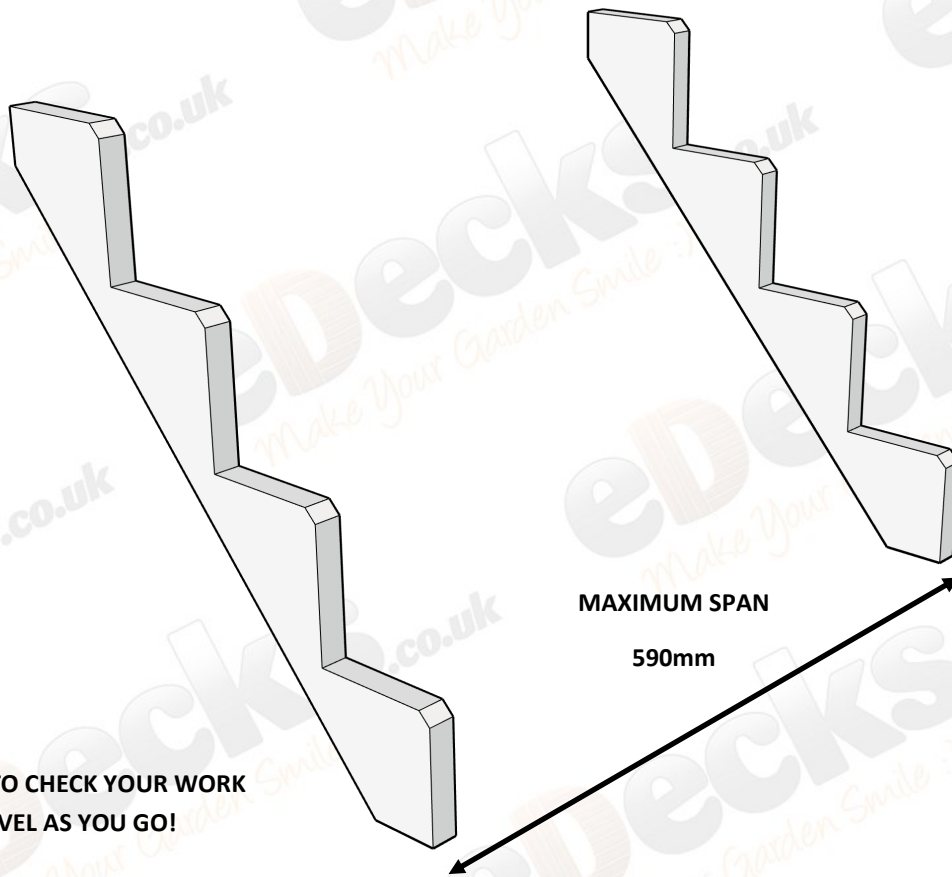
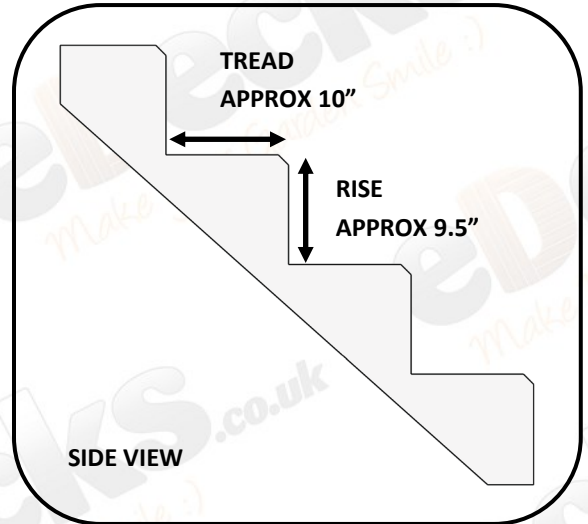

DON'T FORGET TO CHECK YOUR WORK WITH A LEVEL AS YOU GO!

All images are for illustration only. Please see individual item listings for actual item specifications.

Step Stringers

Fitting Guide

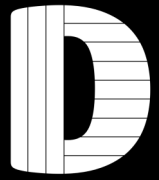

Step 2

FIX STRINGERS INTO POSITION USING TRUSS CLIPS

First attach your truss clip to the top end of your stringer, using 5 x 30mm twist nails on each side.

With the truss clip attached the stringer you can now go ahead and offer up the stringer to your supporting surface and secure in place using 2 x 140mm joist screws and 7 x 30mm twist nails into the remaining holes in the truss clip.

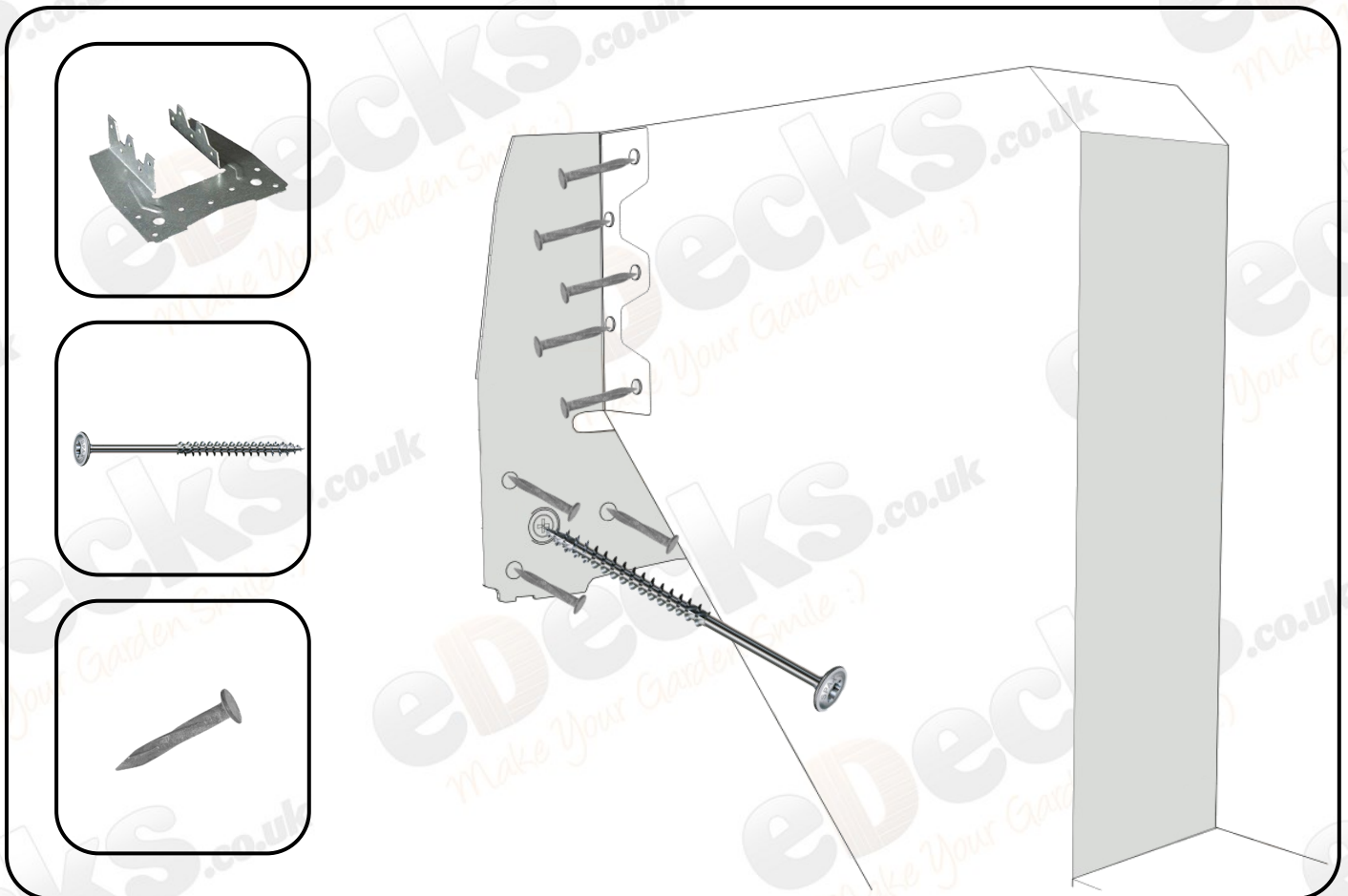

**DON'T FORGET TO CHECK YOUR WORK
WITH A LEVEL AS YOU GO!**

Step Stringers

Fitting Guide

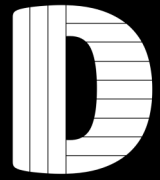

Step 3 - (Not Required for 2-12 Step Stringers)

ADD SUPPORT POST

The post supplied with your kit is designed to be placed somewhere near to the middle of your stringer to offer additional support and reduce any chances of flex or movement; the exact placement is at your discretion however we recommend placing as close to the centre as is possible for maximum strength.

Posts are supplied approximately 600mm longer than would be required so that you have enough extra length to bed this into the ground and concrete into place. If you are planning to use a bolt down anchor to secure your post then you will need to cut 600mm off the post so that it is the right length.

The support post can go on either side of your stringer depending on your preference but we recommend that it should be installed on the inside of your stringer. The length of your post will allow for approximately 200mm of the post to go up and above the step in front of it, we recommend using this as a guide to allow you plenty of space to drill your holes and make a strong and secure connection between the stringer and the post.

To fasten the posts to your stringer you will need to drill two holes through both the stringer and post using a 10mm drill bit which will allow you to push the carriage bolts through and fasten with the provided nuts.

The holes should be approx. 100mm apart as per the diagram below.

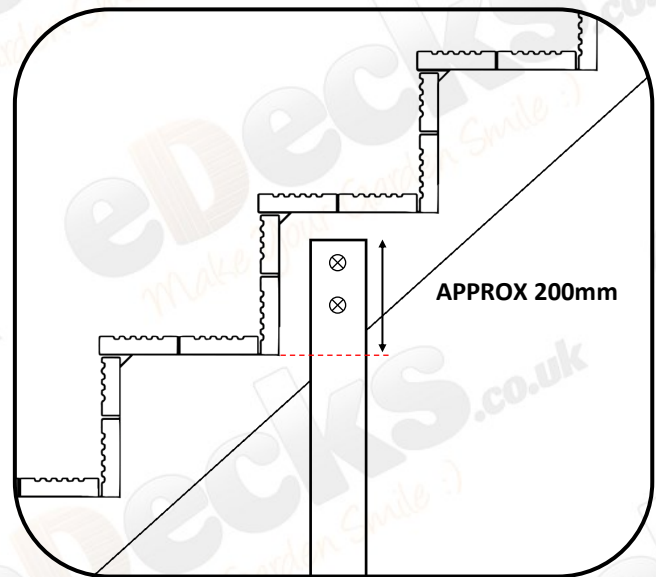
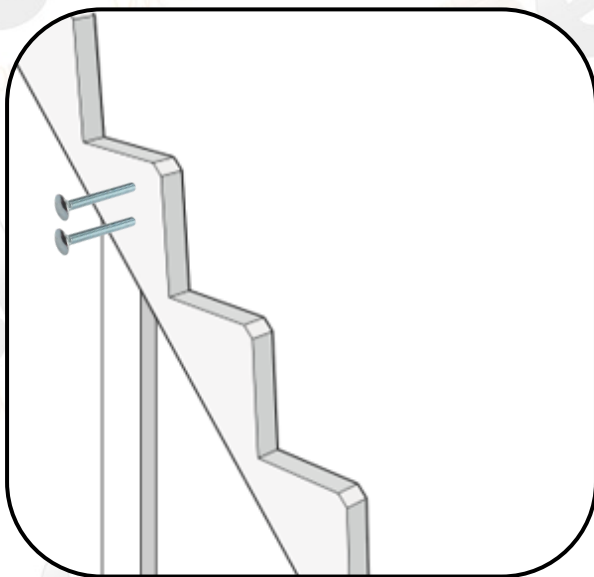

Step Stringers

Fitting Guide

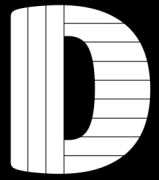

Step 4

SECURE THE 2 BOTTOM BOARDS TO THE STRINGERS

Because of the difference in the rise and the tread they use slightly different decking boards.

The rise (vertical) uses: 1 x full width decking board piece and 1 x ripped down (less wide) board.

The tread (horizontal) uses: 2 x full width decking board pieces.

When building your staircase, you should always start at the bottom.

Begin by securing the 1 x full width decking board piece to the base of the stringers, using 4 x 60mm decking screws 2 at each end of the board to secure the board in place. Once in position secure the ripped down board in the same way, leaving a 5mm gap between the lowest board. The edge of the ripped down board will be visible at this point however it will get covered by the step boards in the next step.

See the below diagram for reference.

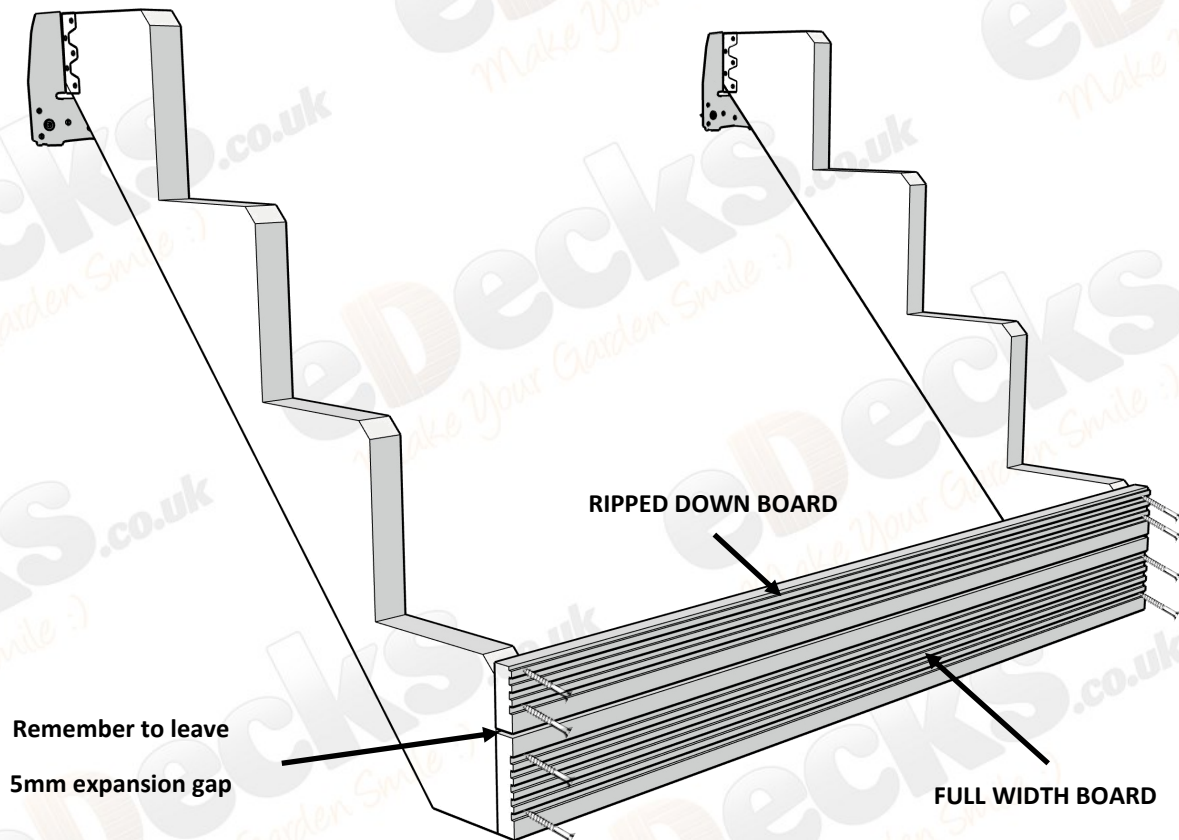

All images are for illustration only. Please see individual item listings for actual item specifications.

Step Stringers

Fitting Guide

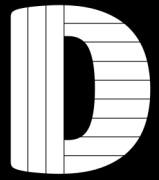

Step 5

SECURE THE REMAINING BOARDS TO THE STRINGERS

In the diagram to the right you will see how the decking boards should be positioned to all fit correctly.

Take note that the boards which are on the rise sit behind the boards of the tread and not on top of them.

As you did with the first two boards, proceed to add the next set of rise boards and secure in place using 2 x 60mm decking screws per board per side, remember to put the full width board on at the bottom and the ripped down above it.

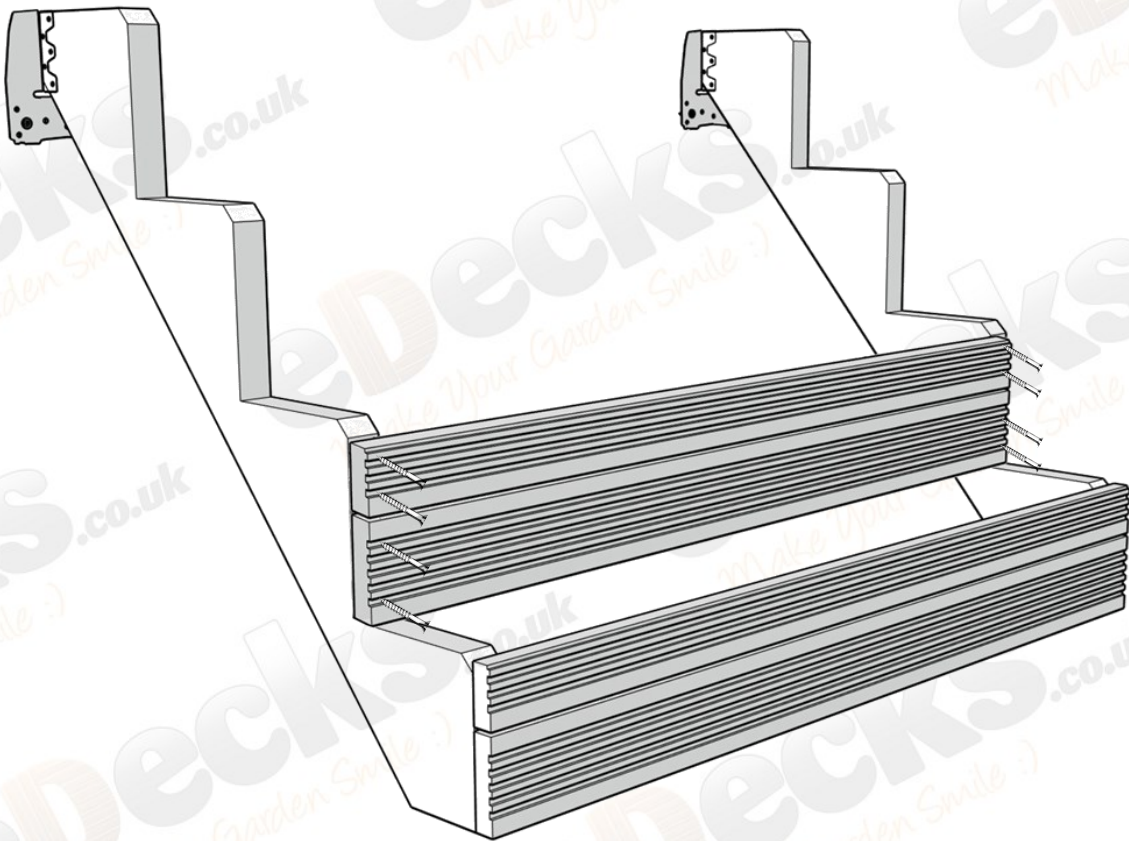
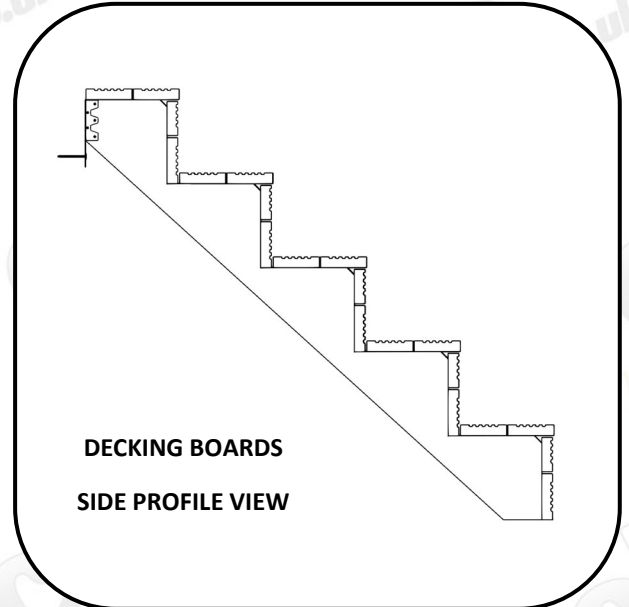

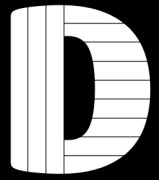

Step 5 Cont'd

SECURE THE REMAINING BOARDS TO THE STRINGERS

With the second set of rise boards fastened in place you can now add your first two tread boards.

Start by placing the first of the 2 full width boards against the riser boards on the stringer and secure in place using 2 x 60mm decking screws per board per side. With the first board fixed into position you can then line up the second full width board to make sure it covers the rip down board on the rise of the step below, once you are happy with its position fasten it down as you have done with the other boards.

To finish your stringers simply repeat the last two steps all the way to the top, remembering to always do the boards on rise first followed by the tread boards.

